

Radio Key® 600

STAND ALONE PROXIMITY ACCESS CONTROL SYSTEM

**with PATENTED*
DYNASCAN® TECHNOLOGY**

Operating & Installation Guide **Rev. I**

P/N 3320831

Secura Key
A Division of SOUNDCRAFT Inc.

A Division of Soundcraft, Inc.
20447 Nordhoff Street
Chatsworth, CA 91311
Phone: 818-882-0020 • Fax: 818-882-7052
Toll Free: (800) 891-0020
website www.securakey.com
E-mail: mail@securakey.com

*Patent #6317027

COPYRIGHT © 2002
SOUNDCRAFT, INC.

Radio Key® 600 Operating & Installation Guide

Table of Contents

Introduction	1
Programming Radio Key® 600	3
Programming Hints	7
Basic Operation	7
System Configuration	8
Wiring	9
Power	11
Installation	14
Troubleshooting	17
Returning a Unit	17
Ordering Additional Transponders	17
Warranty	17
Specifications	18
FCC Certification	23

Illustrations

Figure 1, RK600 Components	2
Figure 2, MOV Wiring Diagram	10
Figure 3, Wiring Diagram	12
Figure 4, Basic Installation	15
Figure 5, Wall Mounting on Metal Surface with Optional Spacer	16
Figure 6, Post/Flange Mounting	16

Tables

Table 1, Cable Types and Distances	9
Table 2, Connector P1 Color Coding	13
Table 3, Connector P2 Color Coding	13

DECLARATION OF CONFORMITY

We, Secura Key, A Division of Soundcraft Inc.
of 20447 Nordhoff Street, Chatsworth, CA 91311, USA

declare under our sole responsibility that the product

Radio Key RK-600

to which this declaration relates, is in conformity with the following standards and/or other normative documents.

I-ETS 300 330, December 1994

ETS 300 683, June 1997

EN 60950: 1992 Incl Amdt 1-4, 11

We hereby declare that all essential radio test suites have been carried out and that the above named product is in conformity to all the essential requirements of Directive 1999/5/EC.

The conformity assessment procedure referred to in Article 10(5) and detailed in Annex IV of Directive 1999/5/EC has been followed with the involvement of the following Notified Body(ies):

BABT, Claremont House, 34 Molesey Road, Walton-on-Thames, KT12 4RQ

(name and address of Notified Body)

Identification mark: 0168 The equipment will also carry the
(Notified Body number) Class 2 equipment identifier



The technical documentation relevant to the above equipment can be made available for inspection on application to:

**Vanhalmé, Lieven Balwemsstraat 13, Industriepark Waggelwater,
8200 Brugge, Belgium**

(name and address of EU representative)

Paul Chandler
(name)

Product Marketing Manager
(title)

Paul Chandler
(signature of authorised person)

11/30/00
(date)

User Information

The following statement will be provided with the equipment as required by Article 6.3 of the R&TTE Directive, 1999/5/EC.

The Secura Key Radio Key RK600 is in conformity with all essential requirements of the R&TTE Directive (1999/5/EC).

This product is marked with **CE 168** which signifies conformity with Class II product requirements specified in the R&TTE Directive.

The following table indicates the areas of intended use of the equipment. Individual licences are not required. For countries not included in this list, please consult the responsible Spectrum Management Agency.

	Country of intended use					
	EU		Non-EU			
	Yes	No	Yes	Yes	No	No
Austria	<input checked="" type="checkbox"/>	<input type="checkbox"/>	Iceland	<input type="checkbox"/>	<input type="checkbox"/>	<input checked="" type="checkbox"/>
Belgium	<input checked="" type="checkbox"/>	<input type="checkbox"/>	Liechtenstein	<input type="checkbox"/>	<input type="checkbox"/>	<input checked="" type="checkbox"/>
Denmark	<input type="checkbox"/>	<input type="checkbox"/>	Norway	<input type="checkbox"/>	<input type="checkbox"/>	<input type="checkbox"/>
Finland	<input type="checkbox"/>	<input checked="" type="checkbox"/>	Switzerland	<input checked="" type="checkbox"/>	<input type="checkbox"/>	<input type="checkbox"/>
France	<input checked="" type="checkbox"/>	<input type="checkbox"/>				
Germany	<input checked="" type="checkbox"/>	<input type="checkbox"/>				
Greece	<input checked="" type="checkbox"/>	<input type="checkbox"/>				
Ireland	<input checked="" type="checkbox"/>	<input type="checkbox"/>				
Italy	<input checked="" type="checkbox"/>	<input type="checkbox"/>				
Luxembourg	<input checked="" type="checkbox"/>	<input checked="" type="checkbox"/>				
The Netherlands	<input checked="" type="checkbox"/>	<input type="checkbox"/>				
Portugal	<input checked="" type="checkbox"/>	<input checked="" type="checkbox"/>				
Spain	<input checked="" type="checkbox"/>	<input type="checkbox"/>				
Sweden	<input checked="" type="checkbox"/>	<input type="checkbox"/>				
United Kingdom	<input checked="" type="checkbox"/>	<input type="checkbox"/>				

Paul Chandler

Name: Paul Chandler
Title: Product Marketing Mgr.

INTRODUCTION

The Radio Key® 600 is a programmable single-door access control system which allows any mix of up to 600 Proximity **Transponders** (Key Tags) or PIN codes for keypad entry. It can control an electric strike, magnetic lock, or gate operator, and has an additional input for an exit switch and output contacts for external alarm shunting. The major components are shown in Figure 1.

The RK600 Access Control Unit contains the CPU, memory, access relay, and an internal reader. It has a beeper, bi-color LED indicator and a 16-position keypad, which is used to add or delete transponders or PIN codes, to set the operating mode, to program the password and latch timer, and for PIN entry. The RK600 is weather resistant and is provided with a gasket for exterior installation.

Parts Supplied:

Access Control Unit

Gasket

MOV

Mounting Plate

Connector/Wire Pigtail

Operating Manual

Quick Start Guide and Wallet Sized Guide

User Log Form

2, 6-32 x 1/2" mounting screws

1, 4-40 x 5/16" Phillips housing screw

1, 4-40 x 5/16" Hex Socket, security housing screw

The RKAR Auxiliary Reader is optional, but recommended for extreme weather or higher security applications. This reader parallels the internal reader in the RK600. It contains a bi-color LED indicator and a beeper also driven by the RK600. A gasket is provided for exterior installation.

The RKAT Audit Trail Module is optional and allows the RK600 to connect to a PC or Printer for Audit Trail Reporting and programming. RK-LINK™ Software for Windows® 95/NT is included.

RK600-PS, a 9VDC plug-in power supply is optional. It is designed to power the RK600 only, and requires 120 VAC input. RK600-BB Back Box / Spacer is optional. It extends the RK600 out from the mounting surface and provides additional room for wiring.

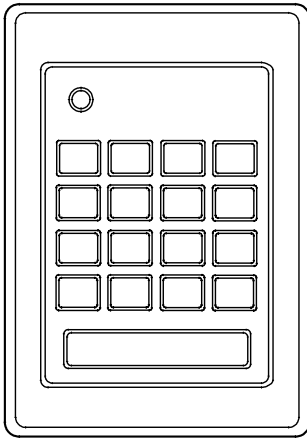

RK600 Unit

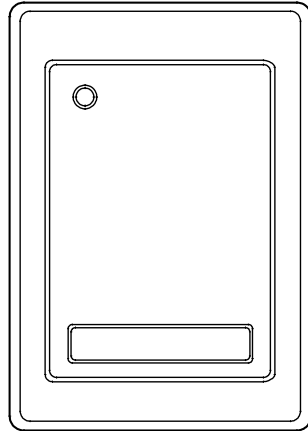

**RKAR
Auxiliary Reader
(optional)**

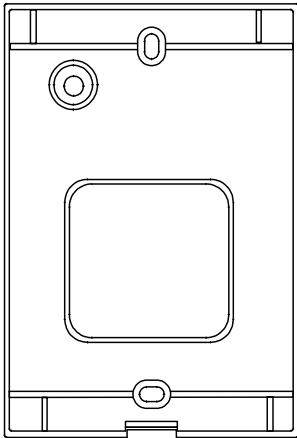

Mounting Plate

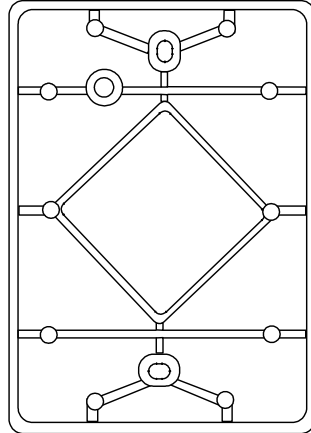

**RK600-BB
Back Box/ Spacer
(optional)**

Figure 1 - RK600 Components

PROGRAMMING RADIO KEY® 600

Radio Key® Transponders (Key Tags) are pre-encoded and engraved at the factory with unique Transponder ID numbers. Because these numbers are unique, Facility Codes (Site Codes) are not required.

Transponder ID Numbers are not pre-programmed into the Radio Key® 600; you must add them to the system as described below.

Radio Key® 600 allows you to assign either a Transponder or a PIN code to each **User Number** (1 - 600) for programming purposes. The User Number is associated with the individual person using the transponder or PIN code.

Be sure to record the User Number, the Transponder ID Number or PIN code and the user's name, and keep this information in a secure place. A blank User Log Form has been included for this purpose. Do not write on this form; use it as a photocopy master.

Because a new Transponder ID Number or PIN can be assigned to any available User Number, the reader always has capacity to store 600 Transponders or PINs, even after many Transponders or PINs have been voided from the reader.

Error Warnings

A red light and three beeps at the end of a keypad sequence means that you have made an error. Refer to the appropriate section, and carefully re-enter the command in the proper sequence.

If you select a User Number for a new Transponder or PIN, and a Transponder ID Number or PIN has already been stored in memory for that User Number, a red light and three beeps will occur. Select another User Number or void the User Number, which removes the previously stored Transponder ID or PIN Number from memory.

NOTE: User Number and ID Number Values in the following examples are for demonstration purposes only; enter the appropriate values for your system.

PROGRAMMING STEPS

To Enter Program Mode:

Enter your 5-digit password, then press **ENTER**. (All new units are pre-programmed with the password 12345.) The LED will flash amber to show that the unit is in Program Mode. The unit will “time out” and return to Active (Normal) Mode in 15 seconds if no key is pressed.

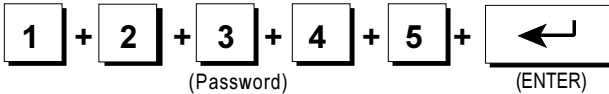

Add a Transponder (Key Tag) to the System:

Enter Password. Press **ENTER**. Press **ADD**. Enter a User Number (1 - 600) and press **ENTER**. Hold the Transponder near the RK600 Unit. A green light and beep means that the Transponder was accepted. A red light and three beeps means a Transponder has already been stored for the selected User Number. Delete the previously stored Transponder or select a new User Number.

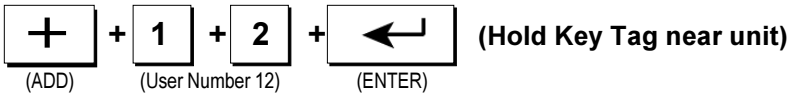

Add a Transponder by Entering the Transponder ID:

Instead of presenting the transponder, you can also use the Keypad to enter the Transponder ID number. **Enter Password.** Press **ENTER**. Press **ADD**, enter the User Number, press *****, enter the ID number printed on the Transponder, then press **ENTER**.

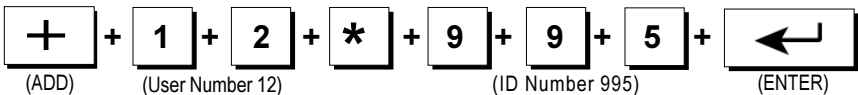

Record the User Number and Transponder ID Number in the User Log Form.

Add a Series of Transponders to the System:

Enter Password. Press **ENTER**. Press **ADD**. Enter the Starting User Number in the range. Press *****, enter the Ending User Number, press *****, then press **ENTER**. Present the Transponders to the reader in the desired order (making a careful record of which transponders are assigned to which User Numbers). If one or more Transponders are already entered into the User Number range you have selected, a red light and three beeps will occur, in which case, you must delete the entire range before proceeding.



Add a PIN to the System:

Enter Password. Press **ENTER**. Press **ADD**. Enter the User Number and press **ADD**, enter the 4-digit PIN code, then press **ENTER**.

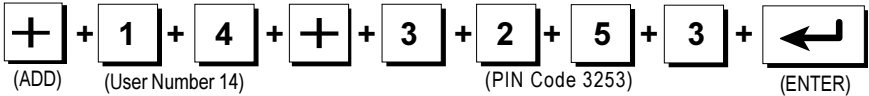

Note: A PIN must be 4 digits. If the PIN has leading zeros, they must be entered as this example shows - "0004".

Delete a Transponder or PIN from the System:

Enter Password. Press **ENTER**. Press **VOID**. Enter the User Number. Press **ENTER**. A green light and beep means that the Transponder or PIN was deleted.

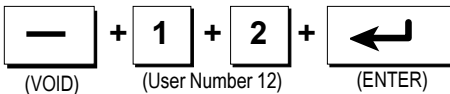
**Delete a Range of Transponders/PINs from System:**

Enter Password. Press **ENTER**. Press **VOID**. Enter the Starting User Number in the range, press *****, enter the Ending User Number, then press **ENTER**. A green light and beep means that the range of Transponders/PINs was deleted.

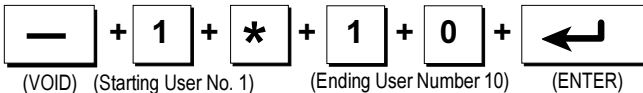
**Delete a Transponder by Presenting to Reader:**

Enter Password. Press **ENTER**. Press **VOID**, then press **ENTER**. Hold the Transponder near the RK600 Unit. A green light and beep means that the Transponder was deleted.

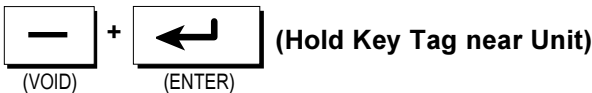
**Delete a Transponder by Entering Transponder ID:**

Enter Password. Press **ENTER**. Press **VOID**, press *****, enter the ID number printed on the Transponder, then press **ENTER**. A green light and beep means that the transponder was deleted.

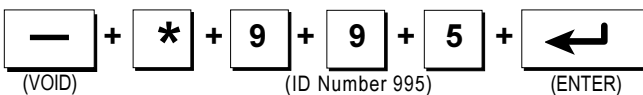

Change your Password:

Enter your current Password. Press **ENTER**. Press *****, then enter the new Password (exactly 5 digits). Press ***** again, then re-enter the new Password and press **ENTER**. A green light and beep means that the Password was changed. Note that 12345 is the default (factory) password; use another number sequence for best security.

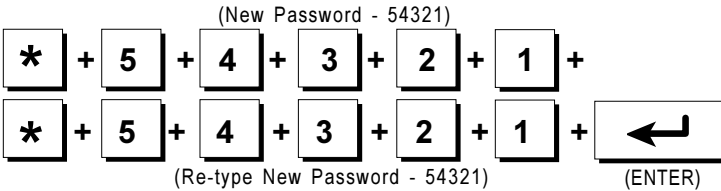

Set the Latch Timer:

Enter Password. Press **ENTER**. Press **SET TIMER**. Enter the number of seconds (0-30). Press **ENTER**. A green light and beep means that the Latch Timer setting was changed.

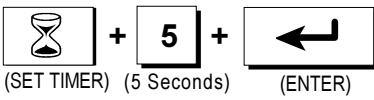

Set the Operating Mode:

Enter Password. Press **ENTER**. Press **MODE**, then press **1**, **2** or **3** and Press **ENTER**. The Access Control Unit will exit Programming Mode and enter the selected Mode. Selections are:

1. Active (Normal) -- LED is Off
2. Inactive (Locked) -- LED blinks Red
3. Door Unlocked -- LED blinks Green

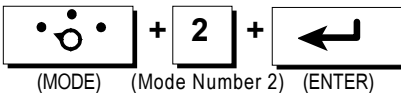

To Exit Programming Mode Immediately:

Press **MODE**, then press **1**, then press **ENTER**. This returns the unit to normal mode immediately, bypassing the 15 second time-out.

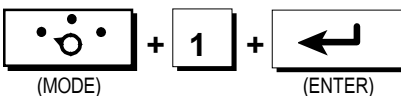

PROGRAMMING HINTS

Password

If the password is lost or forgotten it can be restored to the factory default. Remove the RK600 unit from the mounting plate, disconnect power (unplug the connector from J1 or disconnect the DC power supply) press and HOLD the reset switch (SW1, on the reader circuit board), restore power, then release the switch. Note that this will also reset the latch timer and operating mode to the factory default.

Adding the Same Transponder More Than Once

If you add the same Transponder to the system more than once, the Transponder ID will be deleted from the previous User Number position and added to the newest User Number position. This does not apply to duplicate PIN codes; the same PIN can be assigned to multiple User Numbers.

Setting the Latch Timer

The latch timer controls the latch relay, which has two sets of contacts; one for unlocking the door or gate, and one for bypassing an external alarm system. The factory preset latch time is 1 second but it can be changed to any value from 0.25-30 seconds. If the latch timer is set to 0 seconds, this pulses the latch relay for 0.25 second, sufficient for most electric turnstiles. The beeper and LED are always fixed at one second.

Setting the Operating Mode

Three operating modes are possible. For normal operation select Mode 1; to temporarily lock out all transponders and PIN Codes select Mode 2; to hold the door open continuously select Mode 3.

BASIC OPERATION

To use a Key Tag with Radio Key® 600, simply hold your Radio Key® Transponder near the RK600 Unit or optional Auxiliary Reader. The RK600 Unit or Auxiliary Reader generates an RF field, which causes the Key Tag to transmit a unique Transponder ID Number back to the Auxiliary Reader or RK600 Unit.

If the Transponder ID Number is stored in memory, the latch relay is activated, unlocking the controlled door or gate and shunting any external alarms. A green light and a beep indicates that access is granted.

If the Transponder ID Number is not stored in memory, the door or gate remains locked and a red light and three rapid beeps indicate that access is denied. Otherwise the LED is normally off.

To use a PIN code with Radio Key® 600, enter your User Number, your 4-digit PIN code, then press *. Leading zeros can be omitted for the User Number: enter 2 or 21, not 002 or 021. Zeros must always be entered if they are part of the 4-digit PIN number.

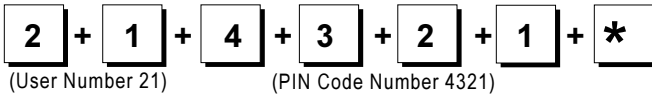

NOTE: If five incorrect PINs (or passwords) are entered, the unit will sound an alarm and display a red LED for 30 seconds, then return to normal mode.

SYSTEM CONFIGURATION

RK600 Unit Only

Locate on the exterior wall, near the latch side of the controlled door. Height should be 36" - 48" (check local codes). Use weather gasket (supplied) for outdoor installations.

RK600 Unit with Optional Auxiliary Reader

Auxiliary Reader - Locate on the exterior wall, near the latch side of the controlled door. Height should be 36" - 48" (check local codes).

RK600 Unit - Locate inside the secure area. For use as an exit reader, mount the RK600 Unit on the interior wall at the same relative location as the Auxiliary Reader but not directly behind it. **For best reading distance, offset the RK600 Unit and Auxiliary Reader by about 6".** Otherwise, the RK600 Unit can be mounted up to 30 cable feet away from the Auxiliary Reader.

Metal Surfaces - Effect on Reading Distance

Normally, Radio Key® 600 will read Key Tags at up to 6". However, when the RK600 Unit or optional Auxiliary Reader is mounted directly on a metal surface, the reading distance decreases slightly. To reduce this effect, install the Spacer (optional) between the mounting surface and the mounting plate; this will restore most of the reading distance.

Vehicle Gate Applications

Optional Auxiliary Reader - Locate 8 - 12 feet in front of gate on driver's side. A Post Mount Adapter or Flange Mount Adapter is available for post mounting. Install the optional Spacer between the mounting adapter and Auxiliary Reader to reduce the effect on reading distance caused by the metal mounting adapter. Alternatively, the RK600 can be used alone, post mounted with weather gaskets.

RK600 Unit - Locate in nearby building, guard house or water-tight (NEMA) enclosure up to 30 cable feet from Auxiliary Reader. For metallic NEMA enclosures, install the optional Spacer between the enclosure wall and RK600 to reduce the effect on reading distance caused by metal. Locate the RK600 in the center of the NEMA enclosure. Non-metallic NEMA boxes will have no effect on reading distance.

Concealed Installation

The optional Auxiliary Reader can be mounted behind any non-metallic wall surface, (glass, wood paneling, plastic, drywall). The reading distance may be affected slightly by metal framework or structural material in the wall.

WIRING

Run the following cables to the RK600 Unit location. Conduit is recommended to reduce the effects of EMI/RFI and for physical protection of the wires.

Table 1 - Cable Types and Distances		
Wire Application	Cable Type	Description
From Power Supply	2-cond, 18-22 AWG	n/a
From Locking Device and power supply or gate operator	2-cond. See Mfr's Specifications	n/a
From external alarm system's Door Monitor Switch (for shunting)	2-cond, 18-22 AWG	250 feet
From Exit Button or PIR	2-cond, 18-22 AWG	250 feet
From Optional Auxiliary Reader	2-cond unshielded 22 AWG, plus a separate 4-cond, shielded 22-24 AWG cable	30 feet

RK600 Wire Connections

The RK600 Unit is supplied with a pre-wired connector (P1) with color-coded wire leads. Referring to Table 2, Connector P1 Color Coding and Figure 3, Wiring Diagram, make all appropriate connections from Connector P1 to the power supply, locking device or gate controller, external alarm circuit and Request-to-Exit (REX) input. Use solder and tape or gel-filled crimp-on connectors.

Note: **Max relay power rating** with resistive load is 2A@24V DC or AC; 0.5A@115VAC. Use an interposing relay to switch greater loads.

The RK600 does not supply power to operate electric strike or magnetic locks - a separate supply is required. Refer to strike/magnetic lock manufacturers instructions.

Users can request to exit through the controlled door without using a transponder or PIN (and without causing an alarm condition), by pressing an Exit button or triggering the relay output of an Exit PIR connected to the RK600 Unit. This will operate the latch relay for the programmed latch time.

When wiring the REX Input, connect the brown wire to one side of the REX switch contact and connect the other side of the switch to the orange wire. This input must be a dry contact, with no voltage present.

Use a Separate Power Supply for Electric Locks
 The access control unit and the electric locking device should be connected to separate power supplies. Install the MOV provided as shown below:

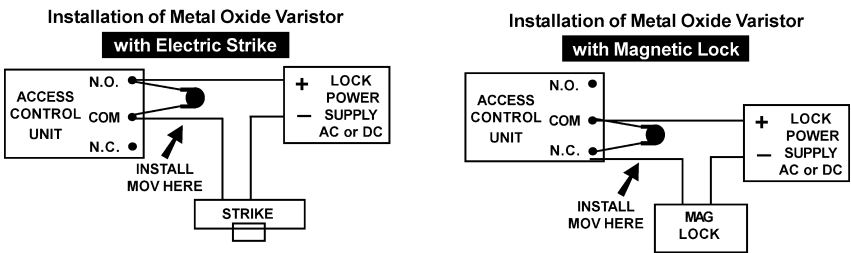

Figure 2 - MOV Wiring Diagram

Auxiliary Reader Wire Connections

A short cable assembly extends from the back of the Optional Auxiliary Reader. Connect Plug P2 at the end of the cable to Socket J2 at the RK600 Unit. If the cable must be extended, for the best performance, use TWO

SEPARATE CABLES: one unshielded, non-twisted, two-conductor wire to the antenna coil (Pins 1 & 2), plus a **SEPARATE** 4-conductor shielded cable to the LED and Beeper (Pins 3 - 6). These cables can be run in the same conduit. Connect the cable shield from the LED/Beeper cable to the black wire (GND) on P1 at the RK600.

Route the auxiliary reader cable at least two feet away from sources of EMI (electro-magnetic interference), such as radio transmitters, elevators, large electric motors or fluorescent light ballasts.

WARNING

Use of any Auxiliary Reader cable which combines all conductors inside one shield and/or uses twisted pair for the antenna lines will result in severely reduced reading distance. Failure to properly ground the cable shield for the LED/Beeper lines will also result in severely reduced reading distance.

Note: When power is applied to the RK600, the unit is calibrated for the current antenna configuration. Always connect the Auxiliary Reader first, before applying power to the RK600.

Surface-Mounted Wiring

For installations where it is necessary to run cable along the wall surface (such as in a wall-mounted modular raceway) small break-away knockouts are provided on the bottom of the RK600 and Auxiliary Reader housings, as well as on the Spacer. Remove the knockouts with small pliers, and butt the raceway up against the opening in the housing to conceal the cable.

Power

The RK600 can be powered by the optional RK600-PS 9VDC power supply, which is rated for powering the RK600 only. Alternatively, use any good 9-14 VDC supply which provides at least 150mA. DC power should be clean and filtered with no more than 1 VAC ripple (Peak to Peak). Do not run AC power in the same cable with DC power to the reader.

WARNING

RK600 will not operate on AC Voltage or with DC polarity reversed.

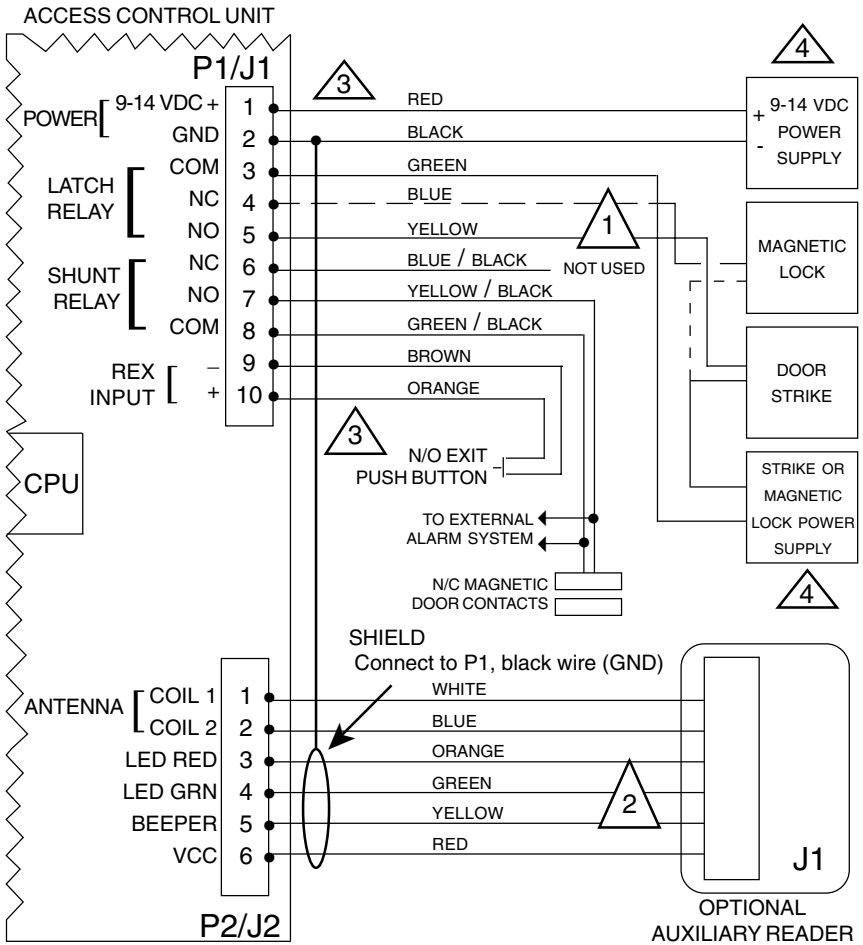

1 SOLID LINE FOR ELECTRIC STRIKE OR OTHER FAIL-SECURE LOCKING DEVICE; DASHED LINE FOR MAGNETIC LOCK OR OTHER FAIL-SAFE LOCKING DEVICE.

2 USE SHIELDED CABLE FOR J2, PINS 3 - 6, AND UNSHIELDED, NON-TWISTED SEPARATE CABLE FOR PINS 1 & 2 (SUCH AS "ZIP CORD", LAMP COARD OR SPEAKER WIRE)

3 USE UNSHIELDED CABLE 18-22AWG FOR PINS 1-10

4 **NOTE:** IF COMMON POWER SUPPLY IS USED FOR BOTH THE RK600 AND ELECTRONIC DOOR LOCK, BE SURE TO INSTALL THE DIODE WHICH IS PROVIDED WITH THE ACCESS CONTROL UNIT.

Figure 3 - Wiring Diagram

Table 2 - Connector P1 Color Coding

Wire Application	Wire	Color	Description
Power Input	1	Red	+9 to 14 VDC
	2	Black	DC Power Ground
Strike/Operator Relay	3	Green	Latch, Common
	4	Blue	Latch, Normally Closed
	5	Yellow	Latch Normally Open
Alarm Shunt Relay	6	Blue/Black	Shunt, Normally Closed
	7	Yellow/Black	Shunt, Normally Open
	8	Green/Black	Shunt Common
REX	9	Brown	REX Input
	10	Orange	REX Input

Table 3 - Connector P2 Color Coding

Wire Application	Wire	Color	Description
Antenna	1	White	Coil 1
	2	Blue	Coil 2
LED Control	3	Orange	LED, Red
	4	Green	Led, Green
Beeper	5	Yellow	Beeper Control
	6	Red	VCC
Shield/ Drain Wire	n/a	Bare Wire	Connect to J1, Pin 2

INSTALLING THE UNITS

Installation Hints

Each unit (RK600 Unit or Auxiliary Reader) consists of two parts: a mounting plate and a housing. The Back Box/Spacer is optional.

When mounting the unit on metal, install the optional Back Box / Spacer (Figure 5) between the mounting plate and the mounting surface to minimize the loss of reading distance caused by the metal. The spacer can also be used on non-metallic surfaces to provide additional room for wiring connections.

When mounting the RK600 Unit and Auxiliary Reader on opposite sides of a wall, offset the units by about 6" for the best reading distance. Do not locate two RK600 units closer than two (2) feet apart. Do not locate the RK600 or RKAR within two (2) feet of a PC Monitor or CPU enclosure, or any other source of EMI (electro-magnetic interference) such as radio transmitters, elevators, large electric motors or fluorescent ballasts.

If the RK600 or Auxiliary Reader must be concealed, the RK-GM glass mount kit can be used to permanently adhere the unit to the back of a glass window. The RK-GM consists of two parts: a large PVC sheet which adheres to the inside of the window, and a smaller adhesive sheet that is used to affix the RK600 mounting plate to the larger sheet. To allow cables to exit the reader housing, remove the small knockout(s) on the bottom of the housing by prying out with small pliers.

Installation Procedure

1. Orient the mounting plate with the threaded insert at the bottom; attach it to a single-gang electrical box with two 6-32 x 1/2" screws (supplied); or attach directly to the wall surface, using anchor screws or toggle bolts (Figure 4).
 - a. If using the optional spacer, insert spacer alignment pins into corresponding holes on the back of the mounting plate, then install both parts so that the spacer is closest to the wall or mounting surface (Figure 5).
 - b. For exterior applications, install the thick gasket between the wall or mounting surface and the back of the mounting plate.
 - c. If using the optional spacer, install the thick gasket between the spacer and the mounting surface, install the mounting plate and spacer using the two 6-32 x 1-1/2" screws supplied with the spacer, then place the thin gasket around the mounting plate (Figure 6).

2. Pull cable ends through the access hole in the mounting plate:
 - a. If using the Auxiliary Reader, connect Plug P2 at the cable end to Socket J2 at the RK600 Unit, grounding the shield at the RK600 Unit end only. The Auxiliary Reader must be connected before power is applied to the RK600.
 - b. Connect Plug P1 to Socket J1 on the RK600 Unit circuit board.
3. Attach the housing to the mounting plate:
 - a. Hold the bottom end of the housing away from the mounting plate.
 - b. Insert the two tabs (inside top of housing) into the two slots at the top of the mounting plate.
 - c. Swing the bottom of the housing toward the mounting plate.
 - d. Secure by installing the 4-40 x 5/16" Philips screw (supplied) into the hole at the bottom. The 4-40 x 5/16" Hex Socket tamper-proof screw (supplied) can be substituted for additional security. The optional security tool (ST-2) is required in order to use the tamper-proof screw.
4. Apply power. The LED will flash once and the beeper will sound. Refer to beginning of this manual for programming and operating instructions.

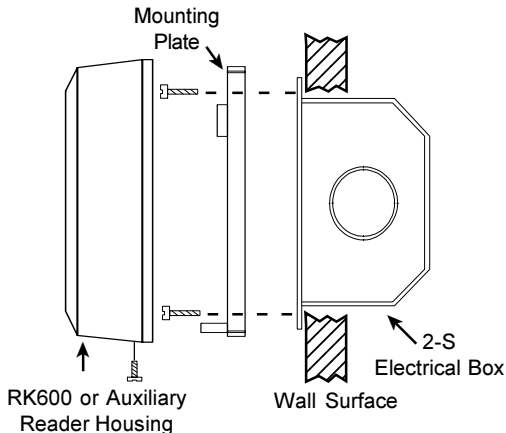
**Figure 4 - Basic Installation**

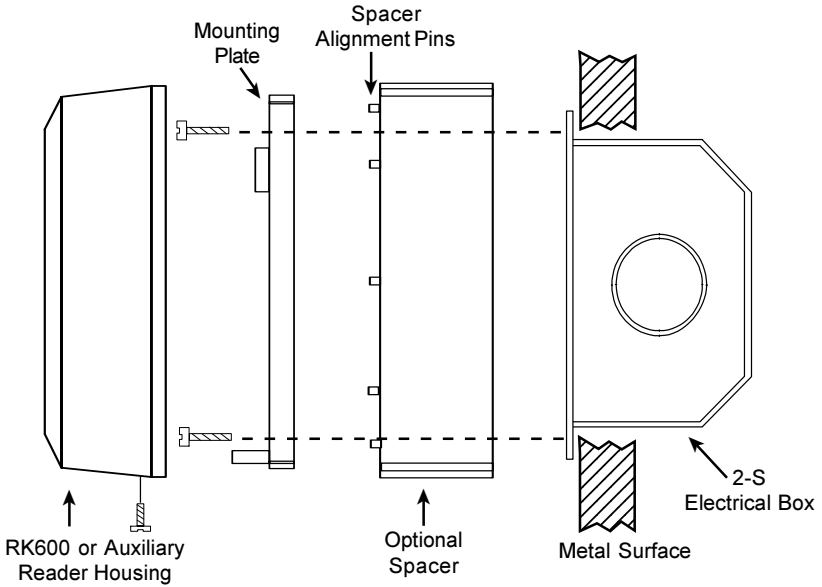

Figure 5 - Wall Mounting on Metal Surface with Optional Spacer

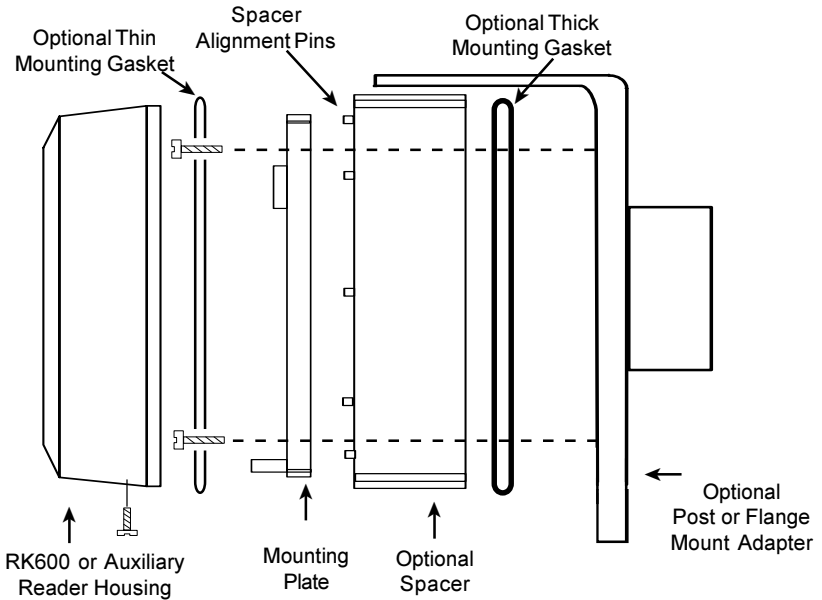

Figure 6 - Post/Flange Mounting

Troubleshooting

If your unit does not appear to be working, first check to see if the RK600 is getting 9-14 VDC power and that the polarity is correct. The unit should make a clicking sound when any key on the keypad is depressed. If you remove and restore power, the unit should beep once and the LED should flash Amber once.

Returning a Unit

If you believe you have a defective unit, please contact the dealer or distributor who sold you the unit. All service and repairs must be done through an authorized dealer or distributor.

Ordering Additional Transponders

If you need additional Transponders, please contact the dealer who sold you the Radio Key® 600 unit. Because Radio Key® transponders are uniquely encoded and do not use facility codes, you can buy them off-the-shelf from any Secura Key dealer. If you do not know who your dealer is, call Secura Key and we will recommend one near you.

WARRANTY (U.S. and Canadian)

“Secura Key products are warranted against defects in materials and workmanship for a period of 2 years from the date of purchase. Secura Key will replace any Secura Key manufactured product, except cards or tags, returned to us freight prepaid within the warranty period. This warranty does not include freight, taxes, duties, or installation expenses. THE WARRANTY SET FORTH ABOVE IS EXCLUSIVE AND NO OTHER WARRANTY, WHETHER WRITTEN OR ORAL, IS EXPRESSED OR IMPLIED. SECURA KEY SPECIFICALLY DISCLAIMS ANY IMPLIED WARRANTIES OR MERCHANTABILITY AND FITNESS FOR A PARTICULAR PURPOSE. The remedies provided herein are the buyers’ sole and exclusive remedies. In no event shall Secura Key be liable for direct, indirect, special, incidental or consequential damages (including loss of profits), whether based on contract, tort or any other legal theory.” Contact Secura Key for Export Warranty Policy.

SPECIFICATIONS**Models**

RK600	Control Unit
RKAR	Auxiliary Reader, Cable

Physical

	<u>Access</u> <u>Control Unit</u>	<u>Auxiliary Reader</u>
Depth	0.84" (2.13 cm)	0.84" (2.13 cm)
Width	3.20" (8.12 cm)	3.20" (8.12 cm)
Height	4.5" (11.43 cm)	4.5" (11.43 cm)
Weight	4 oz (114.5 gm)	2.8 oz (80.4 gm)
Material	Lexan®	Lexan®
Color	Beige	Beige

Power Requirements

9-14VDC, 50mA avg, 150mA Peak

Communications

With Optional RKAT Audit Trail Module, allows connection of PC or Serial Printer (See RKAT data sheet for specifications)

Outputs

Latch & Shunt DPDT contact, 0.5A max@250 VAC or 2A max@24 VAC or DC

Input

Request to Exit Requires SPST contact closure

Environment

Access Control Unit	Ambient Temperature	-40° to +70° C (-40° to +158° F)
	Humidity	0% to 95% non-condensing
Auxiliary Reader	Ambient Temperature	-40° to +70° C (-40° to +158° F)
	Humidity	0% to 100%

Operational

Reading Distance	Up to 6" (15.24 cm)
User Capacity	600 key tags or cards (random numbered) or PINs (User number plus 4 digit PIN)
Key Tag Operation	Passive
Transmit Frequency	125 kHz
Memory	Non-Volatile
Latch/Alarm Shunt Timer	Programmable 0.25 - 30 Seconds
Auxiliary Reader Cable	30' (10m) max. from Control Unit to Auxiliary Reader 2 conductor, non-twisted, non-shielded and 4 conductor shielded

Optional Accessories

RK600-PS	9VDC, 200 mA, plug-in Power Supply, 120 VAC Input. For Access Unit Only.
RK600-BB	Back Box / Spacer - Beige, Lexan®.
RK-GM	Glass Mount Adaptor

This product complies with UL 294 Standards, CE (European Standards) and with the limits for a Class B digital device, pursuant to part 15 of the FCC Rules.

FCC ID: NNHRK600**INSTRUCTION TO THE USER**

This equipment has been tested and found to comply with the limits for a class B digital device, pursuant to part 15 of the FCC Rules. These limits are designed to provide reasonable protection against harmful interference in a residential installation. This equipment generates, uses and can radiate radio frequency energy and if not installed and used in accordance with the instructions, may cause harmful interference to radio communications. However, there is no guarantee that interference will not occur in a particular installation. If this equipment does cause harmful interference to radio or television reception, which can be determined by turning the equipment off and on, the user is encouraged to try to correct the interference by one or more of the following measures:

- Reorient or relocate the receiving antenna.
- Increase the separation between the equipment and receiver.
- Connect the equipment into an outlet of a circuit different from that to which the receiver is connected.
- Consult the dealer or an experienced radio/TV technician for help.

This equipment has been certified to comply with the limits for a class B computing device, pursuant to FCC Rules. In order to maintain compliance with FCC regulations, shielded cables must be used with this equipment. Operation with non-approved equipment or unshielded cables is likely to result in interference to radio and TV reception. The user is cautioned that changes and modifications made to the equipment without the approval of the manufacturer could void the user's authority to operate this equipment.

